



# TMT250

Autonomous personal tracker

Quick Manual  
v1.0

# Table of Contents

<b>Know your device</b> .....	<b>3</b>
<b>Set up your device</b> .....	<b>4</b>
How to insert Micro-SIM card and connect the battery.....	4
PC Connection (Windows).....	5
How to install USB drivers (Windows).....	5
Configuration (Windows) .....	5
<b>LED indication scenarios</b> .....	<b>7</b>
<b>Basic characteristics</b> .....	<b>7</b>
<b>Safety information</b> .....	<b>9</b>
<b>Certification and Approvals</b> .....	<b>10</b>
<b>Warranty</b> .....	<b>11</b>
Warranty Disclaimer .....	11

# Know your device

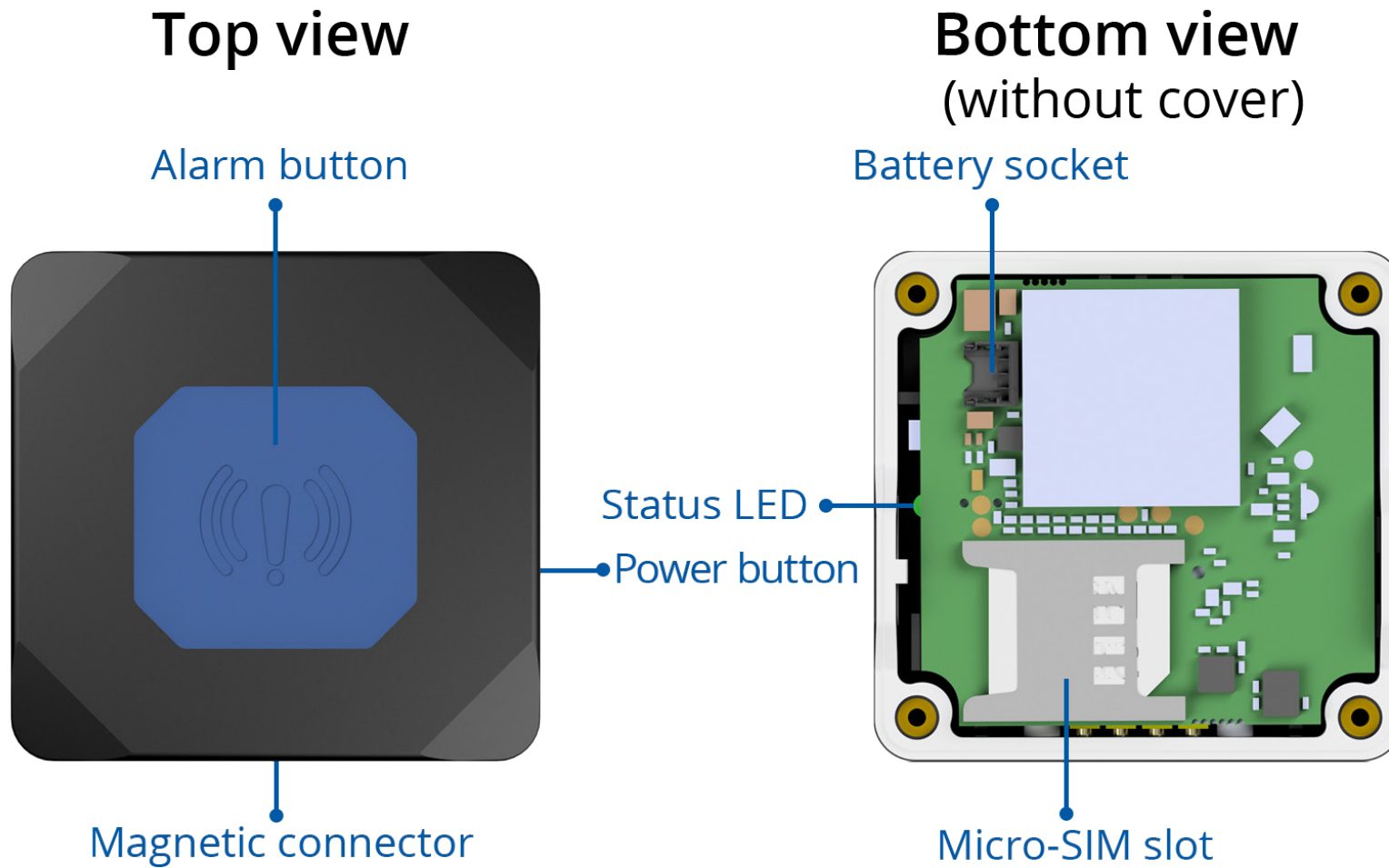
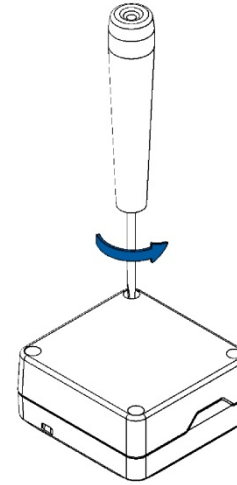

Figure 1 TMT250 device view

# Set up your device

## How to insert Micro-SIM card and connect the battery

1. Unscrew **4 screws** counterclockwise.
2. Remove the **cover**.
3. Insert **Micro-SIM** card as shown with **PIN request disabled** or read our [Wiki](#) how to enter it later with [Teltonika Configurator](#). Make sure that Micro-SIM card **cut-off corner** is pointing forward to slot.
4. Connect the **battery** as shown to device.
5. Attach device **cover** back and **screw** in all screws.
6. Device is ready to be used.



1  
Figure 5 Unscrew screws

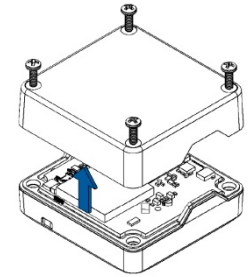

2  
Figure 6 Cover removal

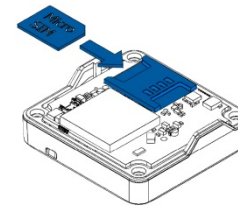

3  
Figure 4 Micro-SIM card insert

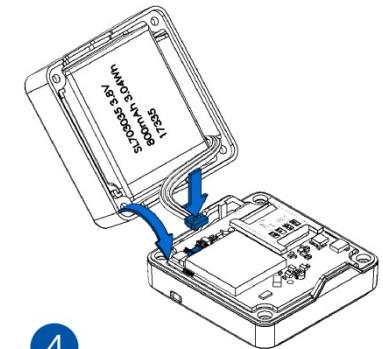

4  
Figure 3 Battery connection

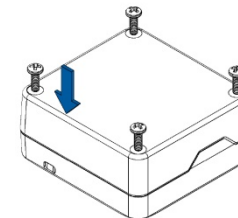

5  
Figure 2 Attaching cover back

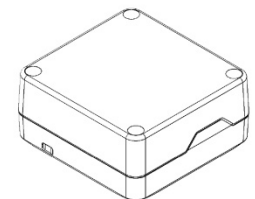

6  
Figure 7 Device is ready

## PC Connection (Windows)

1. Turn on your device by holding the power button for around 5 seconds.
2. Connect your device to computer using **Magnetic USB cable** or **Blue-tooth** connection:
  - Using **Magnetic USB cable**
    - You will need to install USB drivers, see “[How to install USB drivers \(Windows\)](#)”
  - Using **Blue-tooth**
    - TMT250 Blue-tooth is enabled by default. Turn on **Blue-tooth** on your PC, then select **Add Blue-tooth or other device > Blue-tooth**. Choose your device named – “**TMT250\_last\_7\_imei\_digits**”, without **LE** in the end. Enter default password **5555**, press **Connect** and then select **Done**.
3. You are now ready to use the device on your computer.

## How to install USB drivers (Windows)

1. Please download COM port drivers from [here](#).
2. Extract and run **TeltonikaCOMDriver.exe**.
3. Click **Next** in driver installation window.

4. In the following window click **Install** button.

Setup will continue installing the driver and eventually the confirmation window will appear. Click **Finish** to complete the setup.

## Configuration (Windows)

At first TMT250 device will have default factory settings set. These settings should be changed according to the user's needs. Main configuration can be performed via [Teltonika Configurator](#) software. Get the latest **Configurator** version from [here](#). Configurator operates on **Microsoft Windows OS** and uses prerequisite **MS .NET Framework**. Make sure you have the correct version installed.

**Table 1 MS .NET requirements**

### MS.NET REQUIREMENTS

Operating system	MS .NET Framework version	Version	Links
Windows Vista Windows 7 Windows 8.1 Windows 10	MS .NET Framework 4.6.2	32 and 64 bit	<a href="http://www.microsoft.com">www.microsoft.com</a>

Downloaded **Configurator** will be in compressed archive. Extract it and launch **Configurator.exe**. After launch software language can be changed by clicking  in the right bottom corner ([Figure 8 Language selection](#)).

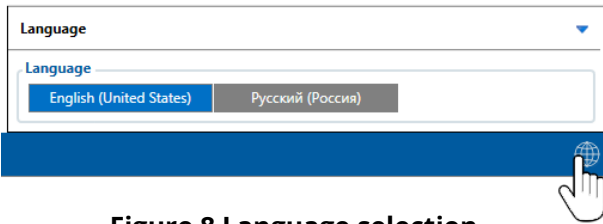

Figure 8 Language selection

Configuration process begins by pressing on connected device (Figure 9 Device connected via USB).



Figure 9 Device connected via USB

After connection to Configurator **Status window** will be displayed (Figure 10 Configurator Status window).

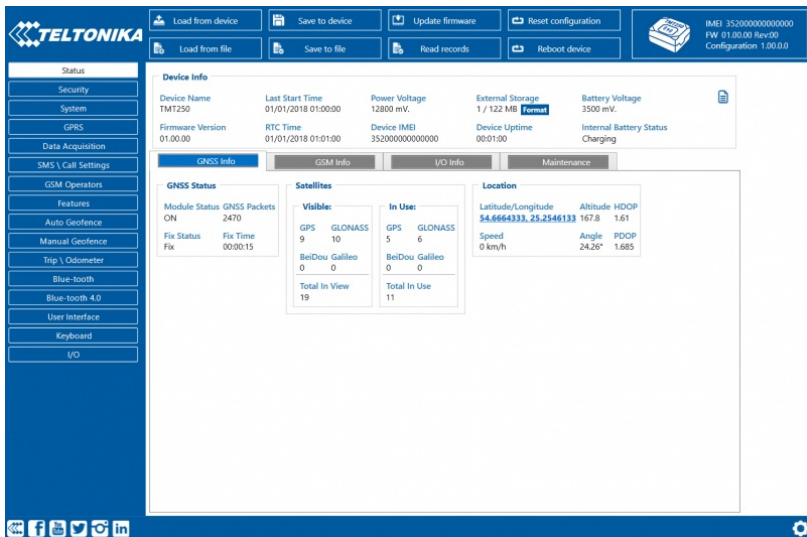

Figure 10 Configurator Status window

Various [Status window](#) tabs display information about [GNSS](#), [GSM](#), [I/O](#), [Maintenance](#) and etc. TMT250 has one user editable profile, which can be loaded and saved to the device. After any modification of configuration the changes need to be saved to device using **Save to device** button. Main buttons offer following functionality:

1. **Load from device** – loads configuration from device.
2. **Save to device** – saves configuration to device.
3. **Load from file** – loads configuration from file.
4. **Save to file** – saves configuration to file.
5. **Update firmware** – updates firmware on device.
6. **Read records** – reads records from the device.
7. **Reboot device** – restarts device.
8. **Reset configuration** – sets device configuration to default.

Most important configurator section is **GPRS** – where all your server and [GPRS settings](#) can be configured and [Data Acquisition](#) – where data acquiring parameters can be configured. More details about TMT250 configuration using Configurator can be found in our [Wiki](#).

# LED indication scenarios

**Table 2 LED indication scenarios**

SCENARIO	MEANING
GSM error	SIM is not inserted, device can't connect to the operator or GSM signal is being jammed
No GNSS fix	Device doesn't have valid GNSS fix and is searching for coordinates
GNSS fix	Device has valid GNSS fix
Device off	Device is turning off
Device on	Device is turning on
Alarm key pressed	Alarm button is pressed and held
Power key pressed	Power key is pressed and held
Charging	Device is charging
Charging error	Overcurrent, low temperature or high temperature
Fully charged	Device is fully charged
Battery low	Battery is almost fully discharged
I am alive	Indication used to remind the user that device is still operational

**Note!** This table contains only the default scenarios. Additional scenarios/default ones can be modified using [Teltonika Configurator](#). User is able to select different indication color (Red, Green or Blue), frequency of LED blinking and vibration status.

# Basic characteristics

**Table 3 Basic characteristics**

MODULE	
Name	TM2500
Technology	GSM, GPRS, GNSS, BLUE-TOOTH
GNSS	
GNSS	GPS, GLONASS, GALILEO, BEIDOU, SBAS, QZSS, DGPS
Receiver	33 channel
Tracking sensitivity	-165 dBm
Accuracy	< 3 m
Hot start	< 1 s
Warm start	< 25 s
Cold start	< 35 s
CELLULAR	
Technology	GSM
2G bands	Quad-band 850 / 900 / 1800 / 1900 MHz
Data transfer	GPRS Multi-Slot Class 12 (up to 240 kbps), GPRS Mobile Station Class B
Data support	SMS (text/data)
POWER	
Charging voltage	5V DC
Battery	800 mAh Li-Ion battery (3,04 Wh)
Power consumption	1,5 mA ( <a href="#">Ultra Deep Sleep</a> )
	3,5 mA ( <a href="#">Deep Sleep</a> )
	4 mA ( <a href="#">Online Deep Sleep</a> )
	8 mA ( <a href="#">GPS Sleep</a> )
	44 mA (nominal)

## BLUE-TOOTH

Specification	4.0 + LE
Supported peripherals	<a href="#">Temperature and Humidity sensor</a> , Headset

## INTERFACE

Configurable buttons	2
GNSS antenna	Internal High Gain
GSM antenna	Internal High Gain
USB	2.0 Magnetic USB contact
LED indication	1 RGB LED
SIM	Micro-SIM
Memory	128MB internal flash memory

## PHYSICAL SPECIFICATION

Dimensions	44 x 43 x 20 mm (L x W x H)
Weight	40 g

## OPERATING ENVIRONMENT

Operating temperature	-25 °C to +55 °C
Storage temperature	-40 °C to +70 °C
Charging temperature	0 °C to +45 °C
Operating humidity	5% to 95% non-condensing
Ingress Protection Rating	IP67

## FEATURES

Sensors	Accelerometer, Gyroscope
Scenarios	<a href="#">Overspeeding</a> , <a href="#">Man-down</a> , <a href="#">Alarm</a> , <a href="#">Auto Geofence</a> , <a href="#">Manual Geofence</a> , <a href="#">Action on call</a> , <a href="#">Movement Event</a>
Sleep modes	<a href="#">GPS Sleep</a> , <a href="#">Online Deep Sleep</a> , <a href="#">Deep Sleep</a> , <a href="#">Ultra Deep Sleep</a>
Configuration and firmware update	<a href="#">FOTA Web</a> , <a href="#">FOTA</a> , FMB Configurator (USB, Blue-tooth), <a href="#">FMBT mobile application (Configuration)</a>
SMS	Configuration, Events, Debug
GPRS commands	Configuration, Debug
Time Synchronization	GPS, NITZ, NTP



# Safety information

This message contains information on how to operate TMT250 safely. By following these requirements and recommendations, you will avoid dangerous situations. You must read these instructions carefully and follow them strictly before operating the device!



**Use only original batteries. Using uncertified manufacturer or different type batteries may cause an explosion.**



**Use batteries safely. Protect batteries from moisture, place them in a cool and dry place when storing. Avoid extensive operation at high temperatures. Do not attempt charging battery directly from the electrical mains. All utilized batteries shall comply with IEC 62133.**



**Power supply circuits used to charge the device connection must have safeguards, which prevent power leakage, short circuits or incorrect electrical grounding. Any used switches ought to be installed in a readily accessible location. Power must be uninterrupted.**



**Remove device safely. Device must be disconnected from computer or charger by unplugging the magnetic USB cable from the device.**



**In order to prevent device from mechanical damage it is advisable to transport it in a shock-resistant packaging. If device stopped working properly regardless of the settings only a qualified specialist can help.**



**Operate the device in suitable conditions. Do not use the device where mobile connectivity is forbidden.**



**Road safety first. Comply with local traffic laws, always hold you hands on a steering wheel when using a device. Your safety is of utmost importance when you drive.**



**All wireless devices are sensitive to electromagnetic interference, as a result wireless devices affect the performance of each other.**



**Charging precautions. SELV LPS chargers, personal computers or laptops that device will be connected to must comply with the requirements of IEC 60950:2005 standard.**

# Certification and Approvals

- [TMT250 IP Rating](#)
- [TMT250 CE RED](#)
- [TMT250 REACH](#)
- [TMT250 Declaration of IMEI assignment](#)

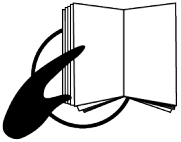

This sign on the package means that it is necessary to read the User's Manual before your start using the device. Full User's Manual version can be found in our [Wiki](#).



This sign on the package means that all used electronic and electric equipment should not be mixed with general household waste.



Hereby, Teltonika declare under our sole responsibility that the above described product is in conformity with the relevant Community harmonization: European Directive 2014/53/EU (RED).

# Warranty

TELTONIKA guarantees its products to be free of any manufacturing defects for a period of **24 months**. With additional agreement we can agree on a different warranty period, for more detailed information please contact our sales manager.

Contact us [teltonika.it/company/contacts](https://teltonika.it/company/contacts)

**All batteries carry a reduced 6 month warranty period.**

If a product should fail within this specific warranty time, the product can be:

- Repaired
- Replaced with a new product
- Replaced with an equivalent repaired product fulfilling the same functionality
- TELTONIKA can also repair products that are out of warranty at an agreed cost.

# Warranty Disclaimer

**TELTONIKA PRODUCTS ARE INTENDED TO BE USED BY PERSONS WITH TRAINING AND EXPERIENCE. ANY OTHER USE RENDERS THE LIMITED WARRANTIES EXPRESSED HEREIN AND ALL IMPLIED WARRANTIES NULL AND VOID AND SAME ARE HEREBY EXCLUDED. ALSO EXCLUDED FROM THIS LIMITED WARRANTY ARE ANY AND ALL INCIDENTAL OR CONSEQUENTIAL DAMAGES INCLUDING BUT NOT LIMITED TO, LOSS OF USE OR REVENUE, LOSS OF TIME, INCONVENIENCE OR ANY OTHER ECONOMIC LOSS.**

More information can be found at [teltonika.it/warranty-repair](https://teltonika.it/warranty-repair)